

CZAKI THERMO-PRODUCT

05-090 Raszyn ul.19 Kwietnia 58
tel. 22 7202302 fax. 22 7202305
handlowy@czaki.pl
www.czaki.pl



Temperature meter

EMT-112

Operating manual

Version 22.12



CE

1 Safety rules

- read these instructions before use
- before turning on the power, make sure that the wires are connected correctly
- ensure operating conditions (power supply, humidity, temperature) according to specifications

2 Characteristics of the device

EMT-102 is a microprocessor-based temperature meter designed to work with thermoresistive sensors (RTD) **Pt100** according to PN-EN 60751, **Ni100** according to PN-83/M53852, thermoelectric (TC) **B, J, K, N, R, S, T** according to PN-EN 60584-1 or semiconductor DS18B20.

It is designed to be installed on a board or control panel.

It is characterized by high accuracy, low power consumption and immunity to interference in industrial environment. It has a digital readout with a display resolution of 0.1°C or 1°C

3 Technical data

General:

Execution	type of sensor	indication range (°C)
EMT-102-Pt100	Pt100	-199 ... 850
EMT-102-Ni100	Ni100	-60 ... 180
EMT-102-J	Fe-CuNi	-199 ... 1200
EMT-102-K	NiCr-NiAl	-199 ... 1370
EMT-102-N	NiCrSi-NiSi	-199 ... 1300
EMT-102-T	Cu-CuNi	-199 ... 300
EMT-102-S	PtRh10-Pt	0 ... 1700
EMT-102-R	PtRh13-P	0 ... 1700
EMT-102-B	PtRh30-PtRh6	400 ... 1800
EMT-102-DS	DS18B20	-55 ... 125

- lead resistance for RTD (Pt100/Ni100) < 10 Ohm per wire
- Electronic temperature compensation for cold ends of thermocouples

LED digital readout (4 digits):

- display range -999 - 9999
- height of digits 20 mm
- LED color Red

Accuracy (for ambient temperature of 23°C±5°C):

- RTD sensors (Pt100/Ni100)..... 0.15% of the indication range ± 1 digit
- TC thermoelectric sensors 0.15% of indication range ± 1 digit
- additional error of compensation of cold ends ± 0,4°C
- DS semiconductor sensors ± 0.5°C for the range -10 ... 85°C
± 2°C for range < -10 and > 85°C

Display resolution (automatically switchable):

- for range -99.9 ... 999,9 0,1°C
- for range < -100°C and >1000°C 1°C

Signaling (message on the display):

- power on Init for 5 sec.
- sensor range exceeded bottom ErLo
- sensor range exceeded top ErHi

Board enclosure 96 x 48 x 80 mm (260g)

- recessed window 92 x 45.2 mm
- mounting with brackets on the sides
- front panel material Polycarbonate
- body material self-extinguishing Noryl

Degree of protection of the housing:

- front side Ip61
- from connector side Ip30

Power supply:

- main 230V AC (+10% - 15%), 50Hz, 3VA
- LV low-voltage (optional) 10-30V DC, 2W

Alarm output:

- type switching relay contacts
- max, continuous current of relay contacts ... 5A
- max. contact voltage..... 250V AC, 30V DC
- max. Switching power 1250 W
- max. switching capacity at rated load..... 600 cycles/hou
- r- max. number of connection without load.... 7200 cycles/hour

Operating temperature: -25°C...+50°C

Relative humidity: 0 - 90% RH non-condensing

EMC compatibility: industrial environment

-Immunity according to PN-EN 61000-6-2:2002(U)

-emissivity according to PN-EN 61000-6-4:2002(U)

4 Installation recommendations

General notes:

- mount in the board with mounting brackets
- do not power the device from the same lines as high power devices without appropriate filters
- avoid running sensor cables in the immediate vicinity and parallel to power lines
- avoid the proximity of devices generating high impulse interference
- include a delay-free 1A fuse in the power supply circuit

Connection of thermoresistive sensors (RTD) Pt100 / Ni100:

- copper connection wires should have equal length and cross section
- it is recommended to connect sensors using the 3-wire method
- if the distance between the meter and the sensor is not large (2-3m), it is acceptable 2-wire connection
- 2-wire method introduces an error of 1°C for each 0.4 of cable resistance

Connection of thermoelectric sensors (TC) B, J, K, N, R, S, T:

- the thermoelectric sensor must be connected with a suitable wire compensation
- connecting the sensor with copper wires will introduce a significant measurement error

Connection of 1-wire semiconductor sensors (DS18B20):

- the sensor should be connected using a 3-wire cable with the smallest possible capacitance between wires
- the sensor must be connected according to the following drawing, incorrect connection risks damage to the sensor

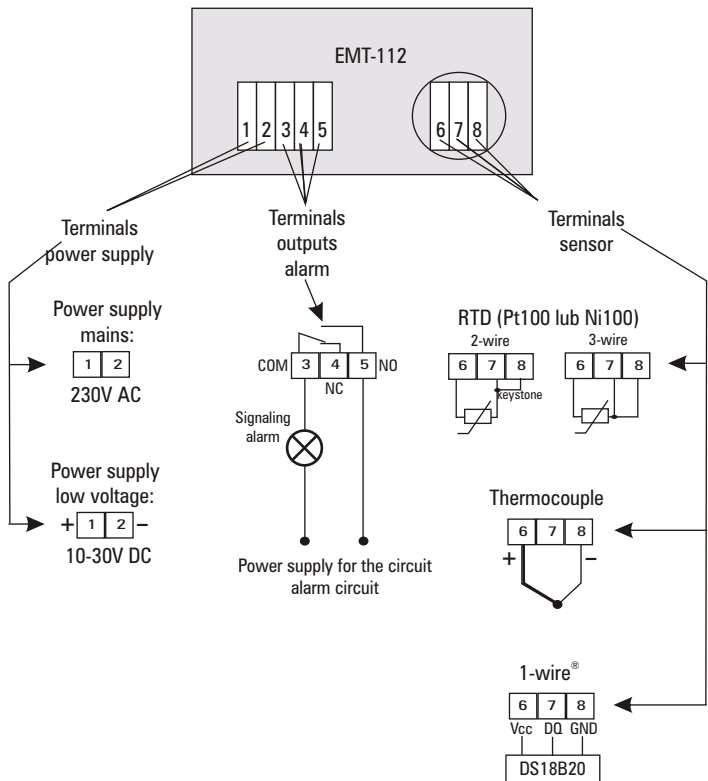

How to connect the power supply and sensor to the EMT-122.

5 Hangling of the meter

- after proper installation, the meter is ready for operation
- the meter does not require periodic maintenance

Inspection of the meter working with RTD (Pt100 / Ni100):

- connect a test resistor in place of the sensor (to terminals 6-7-8), the meter should show the temperature corresponding to the resistance of the resistor (the meter is supplied with a control resistor 70...80°C)

Control of the meter working with TC thermocouples:

- shorten the input terminals of the sensor (terminals 6-8), the meter should show the ambient temperature (terminals)

Alarm:

The EMT-112 meter is equipped with a relay output with short-circuit contacts (alarm output). This output, can be used by the user to monitor the temperature, inform about the current status of the process or protect the object from overheating (cooling down). At the user's disposal are both normally open (NO) and normally closed (NC).

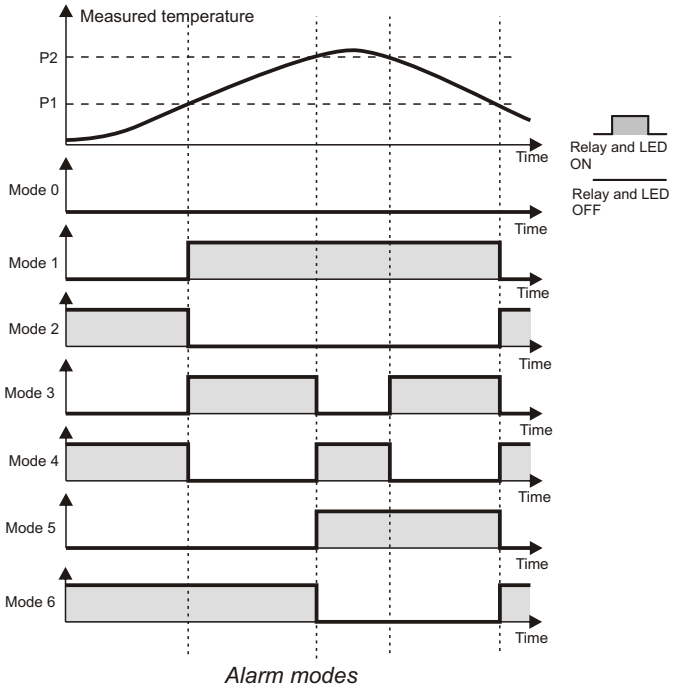

mode 0 - inactive alarm

Mode 1 - above

mode 2 - below

mode 3 - between

mode 4 - extreme

mode 5 - simple ON/OFF controller with hysteresis for cooling

mode 6 - simple ON/OFF controller with hysteresis for heating

The alarm output, depending on your needs, can be configured for six different modes of operation:











- mode 0 alarm is disabled
- mode 1 "above", the relay is activated when the temperature rises above the indicated value (threshold P1)
- mode 2 "below", the relay turns on when the temperature drops below the indicated value (threshold P1)
- mode 3 "between", allows you to signal that the measured temperature is between two indicated values (P1 threshold and P2 threshold)
- mode 4 "beyond", the alarm signals that the measured value fell below the set value (threshold P1), or increased above the set value (threshold P2)
(e.g. temperature is not within the required range)
- **Mode 5**, a simple two-valve regulator with hysteresis, is suitable for connecting a refrigerator, the relay turns on when the temperature exceeds the preset value (threshold P2) and turns off when the temperature drops below the set value (threshold P1)
- **Mode 6**, a simple two-valve controller with hysteresis, is suitable for connecting a heater, the relay is on until the temperature exceeds the setpoint (threshold P2) and turns on again after the temperature drops below the set value (threshold P1). The width of the hysteresis zone (i.e. the difference between the P1 comparison threshold and the P2 comparability) should be selected experimentally, starting with a large width, then reducing it to such a level that it does not decrease to such a level that undesired oscillations do not occur. The optimal width of the hysteresis zone will depend on the dynamics of the object being stabilized.

Factory settings:

Mode	0
P1	0.0
P2	0.0

Configuration of the alarm output:

Configuration of the alarm output is done by two , or three parameters: operation mode, P1 threshold and possibly P2 threshold.

To change the settings of the alarm output, press and hold for about 3 seconds the key  , Until the display reads: "nodE" (mode). Use the  /  keys to select the desired parameter for editing: the alarm mode (on the display "nodE"), the threshold value P1 (on the display "P1") or the threshold value P2 (on the display "P2"), or the desire to end (on the display "End") and confirm with the key  . The display will show the edited value: either the alarm mode or the current alarm threshold value. Use the  /  keys to select the desired value, and then confirm with the key  , which takes you to the level of parameter selection for editing and the possibility of editing another parameter. When the configuration is complete, to return to the measured temperature display mode, use the  /  keys to select "End" on the display and confirm with the key  .

To indicate that the display shows the alarm threshold value and not the currently measured temperature, the decimal point is lit on the last segment.

Alarm threshold limit values are closely related to the type of sensor the meter is dedicated to work with, see the column "Display range " in the section "Technical data".

To disable the alarm function, select the value "0" while editing the value of the alarm mode.

In case of power failure of the meter, the relays always turn off (monostable relays)

6 Package contents

- meter with two mounting brackets
- test resistor (applies to EMT-112-Pt100 and EMT-112-Ni100)
- instruction manual with warranty card