

CZAKI THERMO-PRODUCT

ul. 19 Kwietnia 58
05-090 Raszyn-Rybie
tel. (022)7202302
fax. (022)7202305
www.czaki.pl
handlowy@czaki.pl



TEMPERATURE CONTROLLER

R - 701

USER'S GUIDE

1. Temperature controller characteristics	3
2. Connection diagram	3
3. Front panel description.....	4
4. Modes of work.....	8
4.1. Setting the value of temperature set.....	9
5. Algorithm of control	10
5.1. On/Off & On/Off with hysteresis.....	10
5.1.1. The choice of algorithm On/Off.....	11
5.1.2. Setting hysteresis value.....	12
5.2 Algorithm P,PI,PID	13
5.2.1. Setting proportional gain.....	15
5.2.2. Setting integraltime constant	16
5.2.3. Setting derivative time constant	17
5.2.4. Setting pulse repetition period value.....	18
6. Alarm	19
6.1. Setting alarm mode	20
6.2. Setting first threshold value of alarm.....	21
6.3. Setting second threshold value of alarm.....	22
7. Communication.....	23
7.1. Setting controller address.....	24
7.2. Setting speed of transmission.....	25
7.3. Setting transmission control mode.....	26
7.4. Communication protocol	27
7.5. Measured cycle period.....	27
7.6. Saving results mode.....	27
7.7. Printing results mode.....	27
7.8. List of command.....	28
8. Measuring unit....	29
8.1. Sensors	29
8.2. Resolution of displayed value.....	29
8.3. Offset (shift characteristic)....	29
8.4. The choice of sensor type.....	30
8.5. Setting resolution of displayed value	31
9. System's parameters.....	33
9.1. Protection	33
9.2. Reset	33
9.3. Protection setting.....	34
9.4. Restore factory setting.....	35
Technical data.....	36

1. Temperature controller characteristics

R-701 type temperature controller is a general-urpose single-channel microprocessor unit that performs followins features:

- Its input to be easily adapted to all most often applied types thermocouples and thermoresistors
- PID or hysteresis control algorithm is to be selected by the user
- A relay is operated by five programmable modes
- Double four digit LED-display and supplementary two lamps of relays states
- High power output relay or output for SSR ;
- Sygnalization of sensor damaged

2. Connection diagram

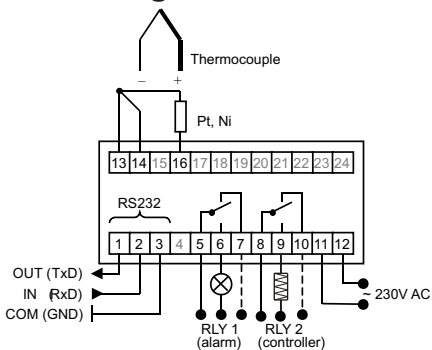

Fig.1 RS-232 version

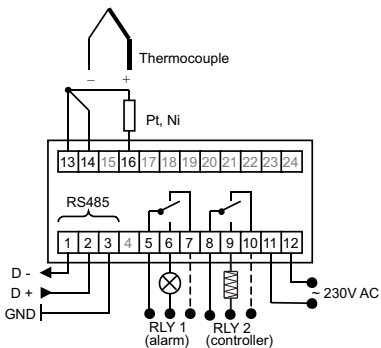

Fig. 1 RS-485 version

	R720	DB 9*	DB 25*
TxD	1	2	3
RxD	2	3	2
GND	3	5	7

* PC serial socket

Tab. 1 Connection between controller and PC computer

3. Front panel description

Controller R-701 has double display and three push-button keyboard placed on the temperature controller front wall. Appearance of the front panel is shown in the figure below:

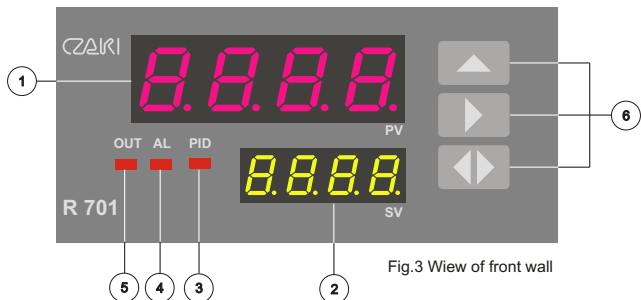





Fig.3 View of front wall

- | | |
|--------------------------------------|----------------------|
| 1 - process temperature display (PV) | 4 - alarm indicator |
| 2 - set temperature display (SV) | 5 - output indicator |
| 3 - PID algorithm indicator | 6 - keyboard |

Key	Controller work mode	Action
Up 	1. NORMAL mode, holding time >3s. 2. MENU mode: - during moving at menu structure - during changing parameter value	- enter to MENU mode - back off about one level in MENU structure - increment about one parameter value
Shift 	1. NORMAL mode, holding time >3s. 2. MENU mode: - during moving at menu structure - during changing parameter value	- modify set temperature (SV) - rewrap next MENU positions - change of modified figure
Enter 	1. NORMAL mode 2. MENU mode	- change displayed value between SV or PWM - confirm choose

Tab. 2 Key functions.

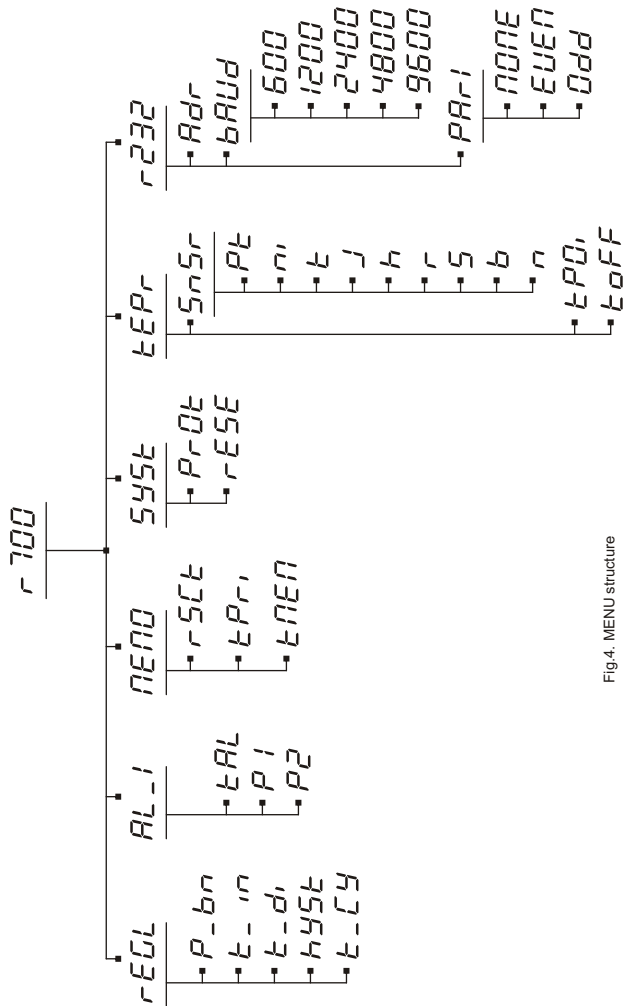

Fig.4. MENU structure

List of parameters and their symbols.

Symbol on display		Range of value	Factory settings	Meaning /sign in manual text
<i>rEGL</i>	<i>P_bn</i>	0.0 ... 99.9	10.0	proportional gain/ P_bn
	<i>t_in</i>	0 ... 1000 [s]	1000 [s]	integral time / t_in
	<i>t_di</i>	0 ... 9.99 [s]	0 [s]	derivative time / t_di
	<i>hyst</i>	0.0 ... 100.0 [°C]	1.0 [°C]	hysteresis / hyst
	<i>cy_t</i>	0 ... 240 [s]	10 [s]	okres impulsowania / cy_t
<i>AL_1</i>	<i>tAL</i>	0 ... 5	0	alarm mode / tal
	<i>P1</i>	-99.9 ... 1800 [°C]	2 [°C]	first level / P1
	<i>P2</i>	-99.9 ... 1800 [°C]	4 [°C]	second level / P2
<i>nENO</i>	<i>rSct</i>	0 ... 240 [s]	10 [s]	read period /rSct
	<i>tPr1</i>	0 ... 2	0	read results / tPr1
	<i>tNEN</i>	0 ... 2	0	save results / tNEN
<i>Syst</i>	<i>PrOt</i>	0 ... 2	0	protection / PrOt
	<i>rESE</i>	0, 1	0	reset / rESE
<i>tEP_r</i>	<i>SnSr</i>	T,J,K,R,S,B,N, Pt100,Ni100	K	sensor type / SnSr
	<i>tPOi</i>	0, 1	0	resolution / tPOi
	<i>tOFF</i>	-9.9 ... 9.9 [°C]	0.0 [°C]	offset / toFF
<i>r232</i>	<i>Adr</i>	1 ... 99	1	meter address / adres
	<i>bAUd</i>	1200,2400, 4800,9600	2400	speed of serial transmission / bAUd
	<i>PAR1</i>	Even,odd,none	none	parity of serial transmission / PAR1

Tab. 3

Attention! Parameters in gray background can be modifying only in |SPEC mode.

4. Modes of work

Controller R-701 can work in two modes:

1. **NORMAL** - controllers executes all charged control and alarm functions. Upper display shown measured temperature, and bottom shown (despide of choose) set temperature (SV) or average power (PWM) expressed in percentages.
2. **SPEC** - realized all functions mode NORMAL and also it makes possible modifying parameters at grey background at table 1.

To enter SPEC mode turn off the unit and next press  button and still pressing that key turned on the unit. Key must be pressed until unit enters to menu.

R-701 offers following types of algorithms:

On/Off with hysteresis, P, PI, PID

Choice between algorithms users makes by setting parameters like in table 2.

Type of controller	P_{bn}	t_{in}	t_d	$HYST$
On/Off	= 0	-/-	-/-	= 0
On/Off with hysteresis	= 0	-/-	-/-	≠ 0
P	≠ 0	= 0	= 0	-/-
PI	≠ 0	≠ 0	= 0	-/-
PID	≠ 0	≠ 0	≠ 0	-/-

Tab. 4

4.1. Setting the value of temperature set.

Value of temperature set can be setting only in NORMAL mode.
The following diagram shows action how to change temperature set.

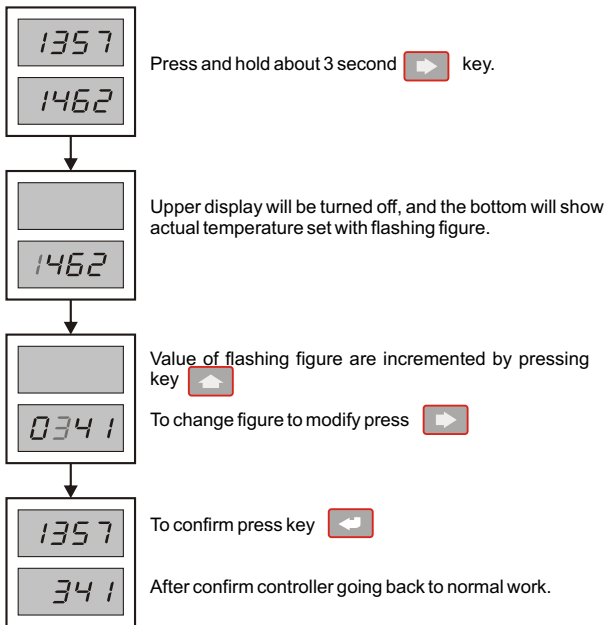

5. Algorithms of control

5.1 Algorithm On/Off type and On/Off with hysteresis.

This algorithm is the simplest type of controller without correction. It means, that output signal may have two values only 0 or 100%.

As it is easy to notice, object temperature (see fig. under) oscillates around temperature set with hysteresis.

Controller with hysteresis is suitable for the objects with small interference influence. In case of the object with high delay values, is accompanied with overshoot.

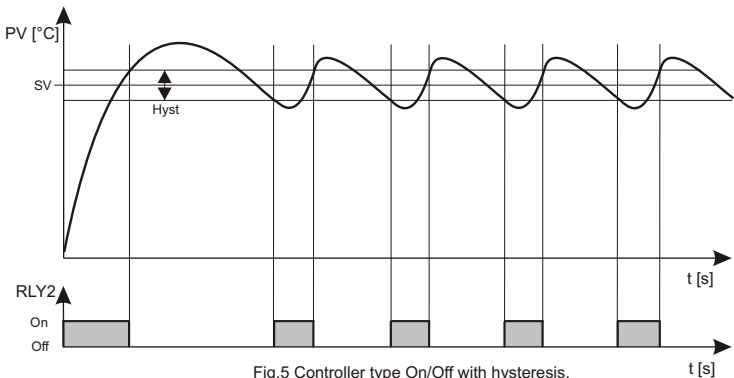
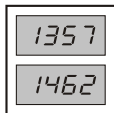

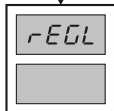



Fig.5 Controller type On/Off with hysteresis.

5.1.1. The choice of algorithm On/Off.



Press and hold about 3 second  key.



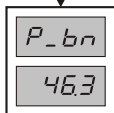

Press the key 

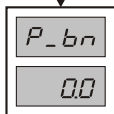

Upper display will show flashing P_bn symbol, and bottom its value. To modify value press key .

After that, modifying value will be flashing.



Value of flashing figure are incremented by pressing the key 

To change figure to modify press 

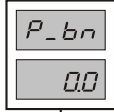

To confirm press .

After confirm flashing value stops, and start flashing parameters name.

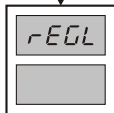

We move about one level higher in structure of menu across press the key 

At this time it is possible to exit menu or choose another parameter to modify.

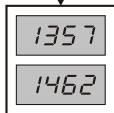

Back to normal controllers work are realized by pressing the key 

5.1.2. Setting hysteresis value.

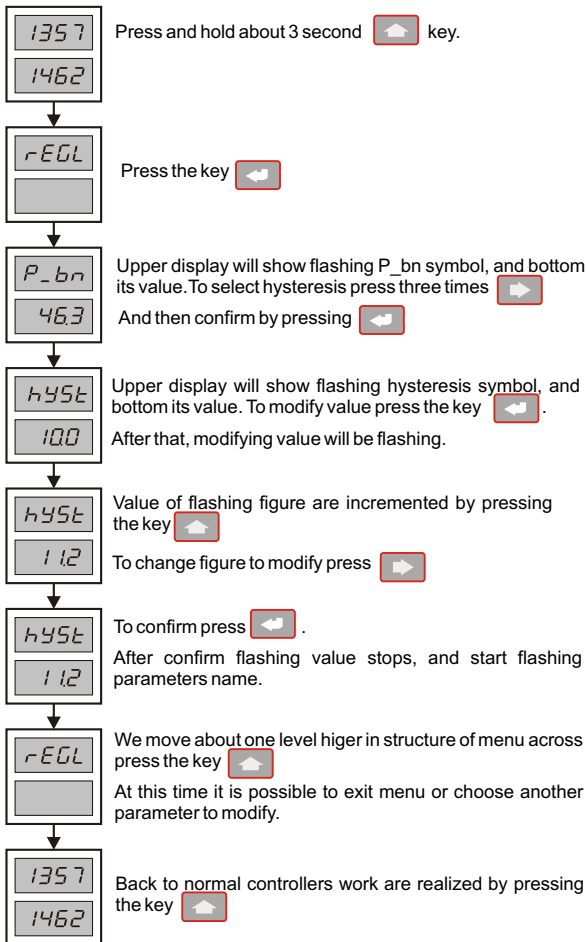

5.2 Algorithm P, PI, PID

Temperature control basing on quasi-linear algorithm proportional (P) integral (I) and Derivative (D) makes possible:

- * selection of characteristics of reaching the temperature set by selection of three parameters
- * easy control of properties of the line object-controller
- * elimination static error
- * smaller interference influence

Gain (P_bn).

Proportional gain (P_bn) in a basic parameter of PID algorithm, it affects in equal degree on all parameters of control algorithm. In case of R-703 controller proportional amplification is expressed in percentages of temperature range (individual for each sensor type).

Increase of proportional amplification increase sensitivity to temperature changes of the object and narrow the linear zone of controller's work.

Integral time-constant (t_in).

The integral element eliminates static component error. Increase of t_in parameter slows down the process of reaching the steady state (SV) of object temperature (PV).

Derivative time-constant (t_di).

The derivative element influences on value of average power between sampling of temperature. If temperature grows up, then derivative element reduces power, the growth temperature slows down. If value of temperature falls down, derivative element increases heater power. Influence of derivative upon heater power is the higher, the higher is the value of derivative time t_di.

This parameter should be used with fast-changed object, where immediate reaction is required on appearing changes.

Pulse repetition period (cy_t).

Value cy_t should be several times shorter than object time-constant. Too small value of this paramater can shorten the time of life relay contacts.

EXAMPLE

temperature set(SV) = 400.0 °C
 temperature measured(PV) = 310.0 °C
 amplification(P_bn) = 10.0
 integral element(t_in) = 0 s
 derivative element(t_di) = 0 s
 pulse repetition period(CY_t) = 10 s
 Tmax. = 1800 °C

PWM value for PV = 310.0 °C

$$PWM = \frac{SV - PV}{PR} \times 100 \%$$

$$PWM = \frac{400.0 - 310.0}{180.0} \times 100.0 \%$$

$$PWM = 50.0 \%$$

proportional range(PR) = (1/P_bn) x Tmax.
 PR = 0.1 x 1800 °C = 180 °C

time of relay on t_on:

linear work range:

$$LW = (SV - PR)$$

$$LW = (400.0 - 180.0) = 220.0 \text{ °C}$$

$$t_{on} = CY_t * PWM$$

$$t_{on} = 10s * 50.0 \%$$

$$t_{on} = 5.0 \text{ s}$$

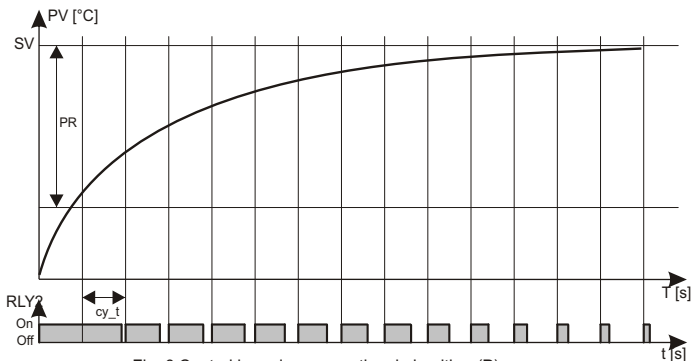
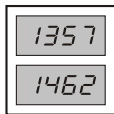

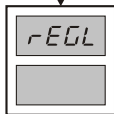



Fig. 6 Control based on proportional algorithm (P)

5.2.1. Setting proportional gain (P_{bn}).



Press and hold about 3 second  key.



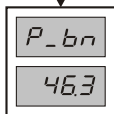

Press the key .

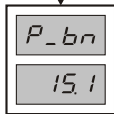

Upper display will show flashing P_{bn} symbol, and bottom its value. To modify value press key .

After that, modifying value will be flashing.



Value of flashing figure are incremented by pressing the key .

To change figure to modify press .

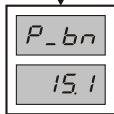

To confirm press .

After confirm flashing value stops, and start flashing parameters name.

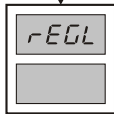

We move about one level higher in structure of menu across press the key .

At this time it is possible to exit menu or choose another parameter to modify.

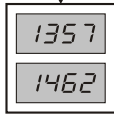

Back to normal controllers work are realized by pressing the key .

5.2.2. Setting integral time-constant value (t_{in}).

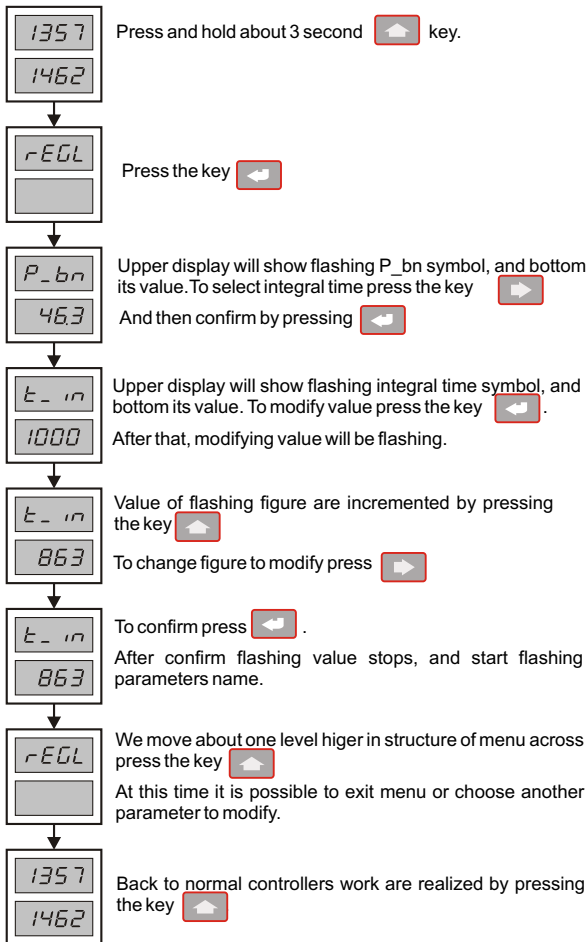

5.2.3. Setting derivative time-constant value (t_{di}).

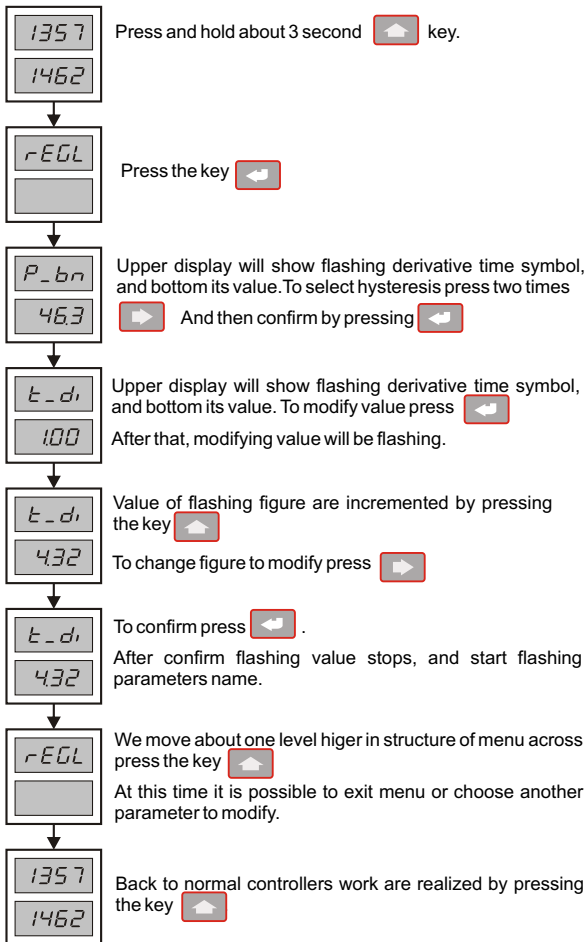

5.2.4. Setting pulse repetition period value (CY t).

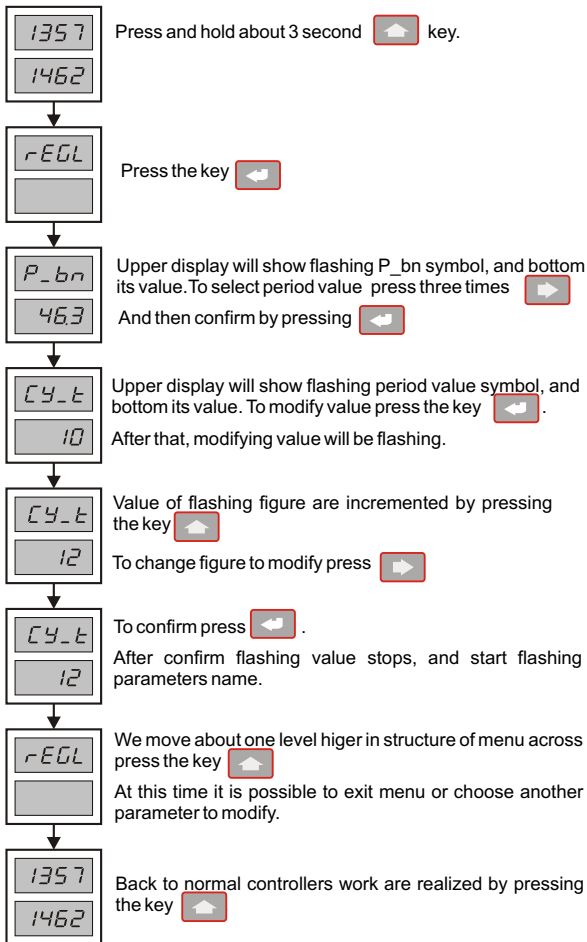

6. Alarm

The R-701 controller is equipped with level alarm, which can work in one of five modes of work. Could be used by user to monitoring the control process, informing about current state of process and possible risk of overheating.

Alarm can be used also as additional control output working in On/Off mode or On/Off with hysteresis mode.

Mode of alarm output illustrates fig. 7 below.

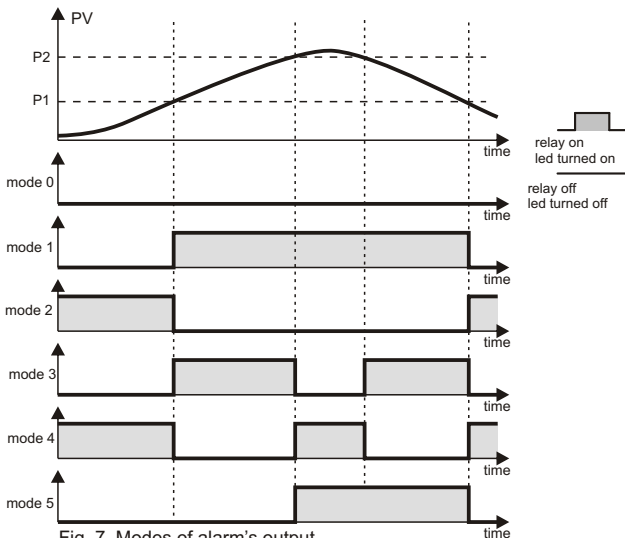
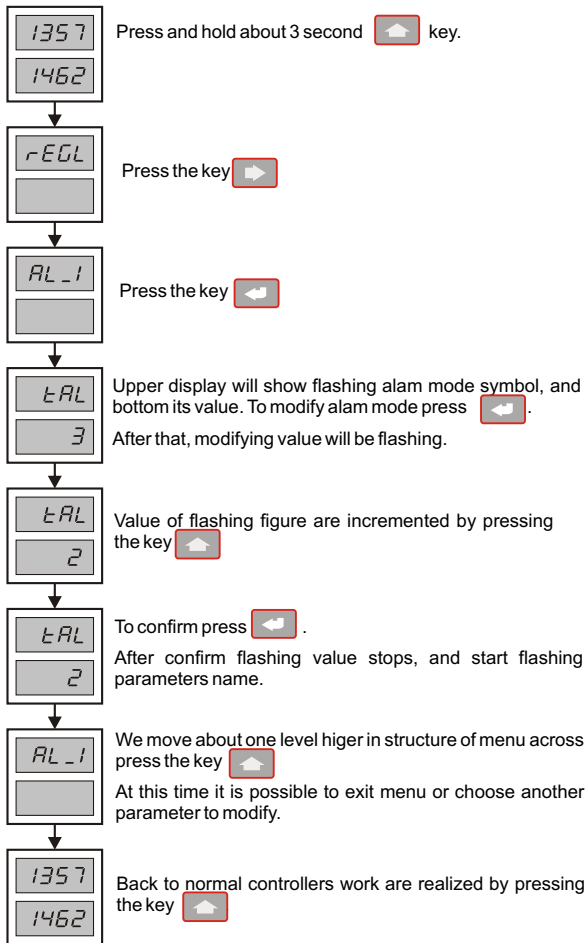

Fig. 7 Modes of alarm's output.

Attention!!!

Value of alarm's level should be $P1 < P2$, in other time alarm didn't work properly

6.1. Setting alarm mode (tAL).



6.2. Setting first threshold value of alarm (P1).

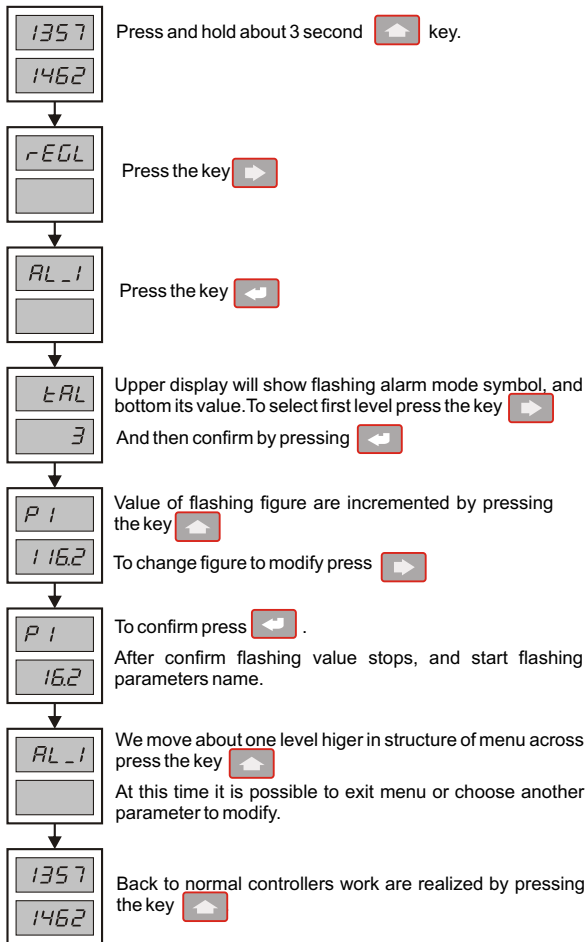

6.3. Setting second treshold value of alarm (P2)6

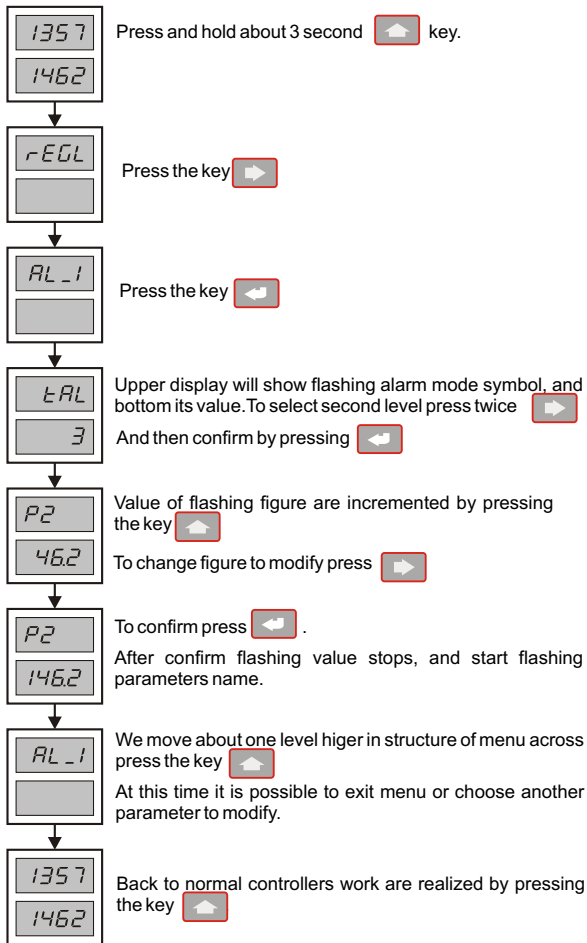

Example.

The drawing represents control using on/off with hysteresis control algorithm, with normal closed relay contacts (NC) alarm's output. Value of level:

P1=110.2 °C, P2=125.7 °C, Tal=5.

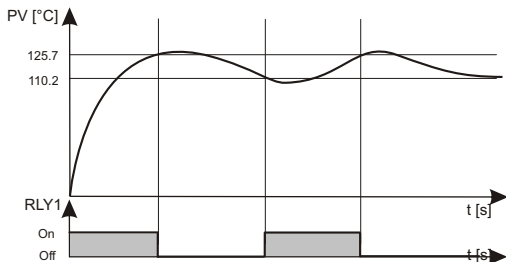

Fig. 8 On/Off controller using alarm's normal close relay contacts

7. Communication

R-701 is equipped with RS-232 serial port (or RS485 in option) interface making possible co-operation with the computer. Serial port working with four different transmission speed. Via serial interface it is possible to read measured temperature and also read and write some internal parameters.

Data between computer and controller are transmitted ASCII code and contains 8 data bits and one stop bit. For correct work user should set up:

- **Transmission speed (baud)**. It is possible one of four transmission speed: 1200, 2400, 4800 i 9600 kbps ;
- **Parity control (PARl)**. Options: even, odd, none
- **Controller address**. Addressing makes possible to work several devices connected to one serial port (RS-485 interface only).

Number of address range is from 0 to 99.

7.1. Setting controller address (Adr).

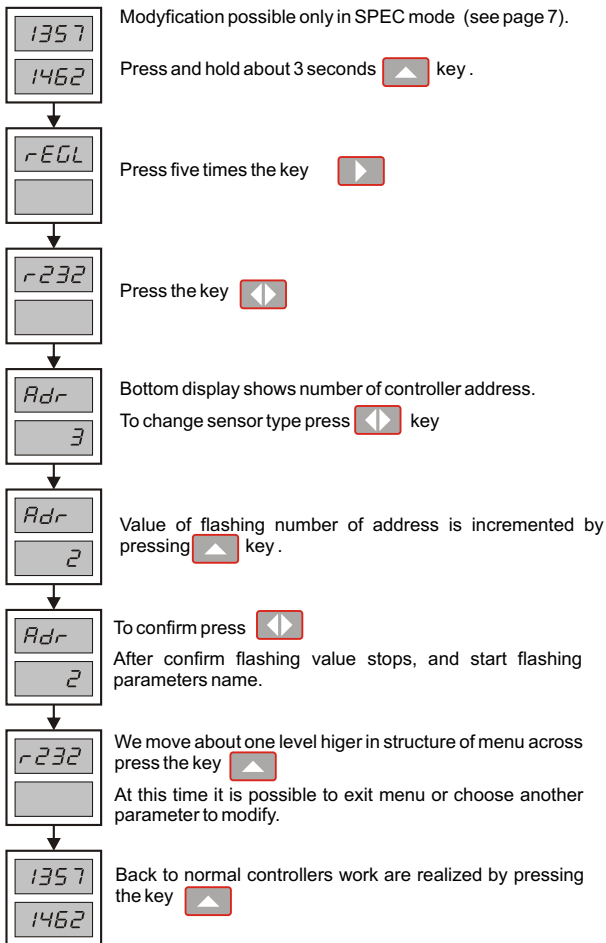

7.2. Setting speed of transmission (bAUd).



Modification possible only in SPEC mode (see page 7).

Press and hold about 3 seconds  key .



Press five times the key 



Press the key 



Bottom display shows number of controller address. To set transmission speed press 

And next confirm by pressing 



Changes between transmission speeds are realized by pressing 

At that time bottom display is showing possible transmission speeds:

600
1200
2400
4800



To confirm press 

After confirm flashing value stops, and start flashing parameters name.



We move about one level higher in structure of menu across press the key 

At this time it is possible to exit menu or choose another parameter to modify.



Back to normal controllers work are realized by pressing the key 

7.3. Setting transmission control mode (PARl).



Modification possible only in SPEC mode (see page 7).

Press and hold about 3 seconds  key .





Press five times the key 



Press the key 



Bottom display shows number of controller address. To set transmission control mode press twice  key

And next confirm by pressing  key .



Changes between transmission control modes are realized by pressing  key .

At that time bottom display is showing possible transmission control modes:

none
EVEN
Odd



To confirm press 

After confirm flashing value stops, and start flashing parameters name.



We move about one level higher in structure of menu across press the key 

At this time it is possible to exit menu or choose another parameter to modify.



Back to normal controllers work are realized by pressing the key 

7.4 Communication protocol

Serial interface enables programming controller without using controller's keyboard. To read value of one parameter, user should use special data format presented at fig.9.

Addressing makes possible changes values of paramaters only in users intresting controller.

In case when address will be equal 00 data will be interpreted by all contacted controllers. Protocol don't recognizes big and small letters. All parameters values, listed below, could be read and write, apart PV value which can be read only.

7.5 Measured cycle period (RSct)

This is period between temperature measurement which is saving in memory or sending via serial interface.

7.6 Saving results mode (tnEn)

R700 offers saving results of measurements in built-in memory. Possible option of saving (state of tnEn parameter):

0 - results are not saving

1- results (max. 300) are saving, when memory will be full, saving will be stoped

2 - result are saving, when memory will be full, saving will be continued by rewriting memory

7.7 Printing results mode (tnEn)

R700 can transmit measured results via serial interface, measured or written in the internal memory.

Possible option of printing (state of tPrl parameter)

0 - results are not sending via serial interface

1- measured temperature results are printing directly by serial

interface (ASCII code) with RSCt time period

2 - stored data (results of measurement) are transmitting via serial interface, this option doesn't erase memory

7.8 List of command

Command code	Description	Attributes	
		R	W
T, t	temperature value (PV)	+	-
A, a	alarm works mode ()	+	+
B, b	first alarm threshold ()	+	+
C, c	second alarm threshold ()	+	+
R, r	measure cycle period()	+	+
P, p	printing results ()	+	+
U, u	saving results mode ()	+	+
S, s	speed of transmission ()	+	+

Tab. 5

Read command (read measuring temperature by controller of 01 address example)

0	1	T	?	□
adres		code		<CR>

R-700 example answer : +0022.8

(exactly: <LF>, '+0022.8', <CR>, <LF>)

Write command (write alarm level example)

0	1	B	+	1	2	5	.	0	□
address		code	+/-	new value					<CR>

Write command (write speed of transmission vaule example)

0	1	S	6	0	0	□
address		code	new value			<CR>

Fig. 9 Command format

8. Measuring unit.

8.1 Sensors (SnSr)

The controller R-701 is universal controller, which work with all kind of sensors offered through Czaki Thermo Product.

* with thermoresistance sensors (PN-EN60751+A2):

- Pt100 => 0.0 ... +850.0 °C;

- Ni100 => 0.0 ... +180.0 °C;

* and thermocouple sensors (PN-EN60584):

- J (Fe-CuNi) => 0.0 ... +1000 °C;

- K (NiCr-NiAl) => 0.0 ... +1200 °C;

- T (Cu-CuNi) => 0.0 ... +230.0 °C;

- R (PtRh13-Pt) => +200.0 ... +1600 °C;

- B (PtRh30-PtRh6) => +400.0 ... +1800 °C;

- S (PtRh10-Pt) => +200.0 ... +1600 °C;

- N (NiCrSi-NiSi) => 0.0 ... +1300 °C;

8.2 Resolution of displayed value (tPOI)

R-701 could displayed measured temperature with 1°C or 0.1°C resolution.

It is depending of parametr TPOI. If TPOI is:

0 - results are displayed with 0.1° C resolution;

1 - results are displayed with 1° C resolution.

8.3 Offset (toFF)

Offset is setting in case of solid difference between real temperature and measure temperature. This parameter can compensate for example, the influence of wires resistance when is udes two-wire thermoresistance sensors.

8.4. The choice of sensor type (SnSr).



Modification only in SPEC mode (see page7).

Press and hold about 3 second  key.



Press four times the key 



Press the key 



Upper display will show flashing sensor symbol, and bottom its type. To change sensor type press 



Changes between sensor types are realized by pressing 

At that time bottom display is showing possible to select types of sensors:

P
t
t
J
h
S
b
n



To confirm press 

After confirm flashing value stops, and start flashing parameters name.



We move about one level higher in structure of menu across press the key 

At this time it is possible to exit menu or choose another parameter to modify.



Back to normal controllers work are realized by pressing the key 

8.5. Setting resolution of displayed value (tPOI).



Press and hold about 3 second  key.



Press four times the key 



Press the key 



Press one time the key 



Upper display will show flashing resolution symbol, and bottom its value. To change resolution press 



Value of flashing figure are incremented by pressing the key 



To confirm press 

After confirm flashing value stops, and start flashing parameters name.



We move about one level higher in structure of menu across press the key 

At this time it is possible to exit menu or choose another parameter to modify.



Back to normal controllers work are realized by pressing the key 

8.6. Setting offset (toFF).

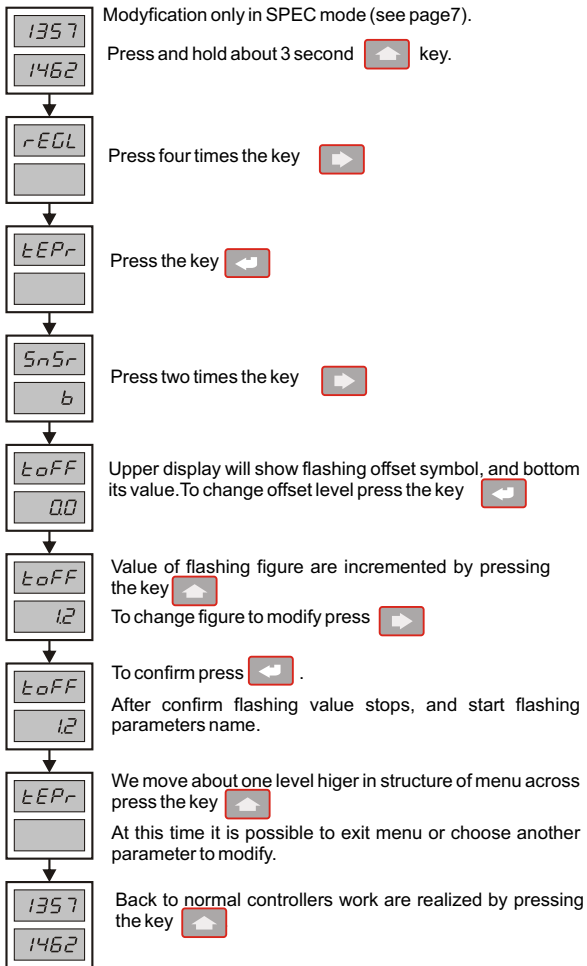

9. Systems parameters.

9.1 Protection

The controllers offers the possibility of blocking set the parameters of work, to making impossible the access unauthorised personnel.

Protection can accept three values:

0 - switched off protections;

1 - protection for all parameters without same protection;

2 - protection for all parameters with protection too;

In this case, all changes are blocked.

Removal protection is possible only in SPEC mode.

9.2 Reset.

This option restores factory setting of parameters from schedule 4.

To restore parameters put value 1, exit from MENU, turned off the unit and again turned on the unit.

9.3. Protection setting (Prot).

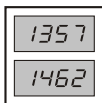

Press and hold about 3 second  key.

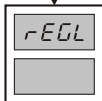

Press three times the key 

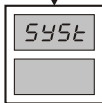

Press the key 

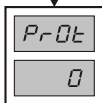

Upper display will show flashing protection symbol, and bottom its value. To change protection level press 

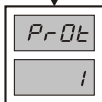

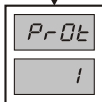

Value of flashing figure are incremented by pressing the key 

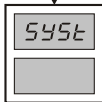

To confirm press 

After confirm flashing value stops, and start flashing parameters name.



We move about one level higher in structure of menu across press the key 

At this time it is possible to exit menu or choose another parameter to modify.

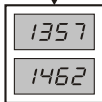

Back to normal controllers work are realized by pressing the key 

9.4. Restoring factory settings (rESE).

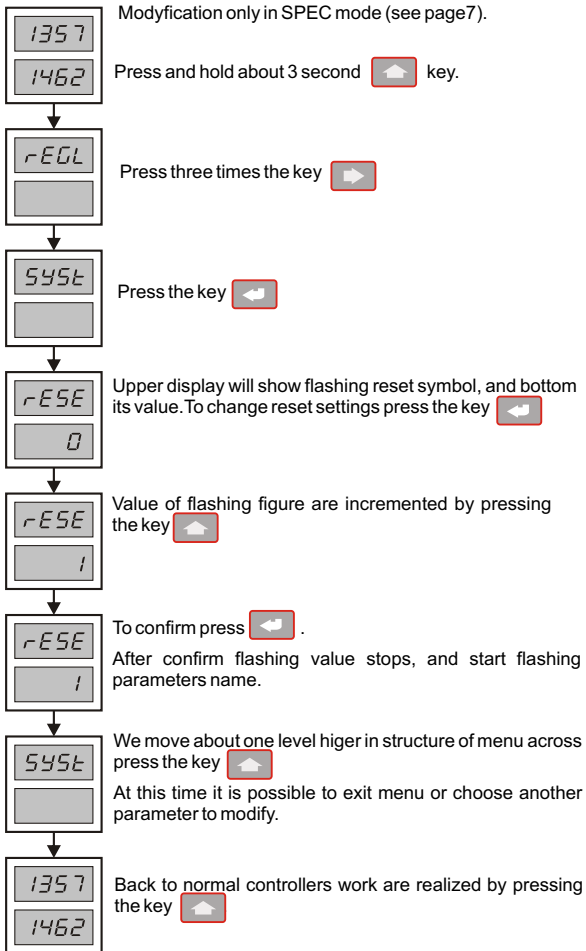

Technical data

Working temperature range	J (Fe-CuNi)	[0 .. +1000] °C
	K (NiCr-NiAl)	[0 .. +1200] °C
	T (Cu-CuNi)	[0 .. +230.0] °C
	R (PtRh13-Pt)	[+200.0 .. +1600] °C
	S (PtRh10-Pt)	[+200.0 .. +1600] °C
	B (PtRh30-PtRh6)	[+400.0 .. +1800] °C
	N (NiCrSi-NiSi)	[0 .. +1300] °C
	Pt100	[0 .. +850.0] °C
	Ni100	[0 .. +180.0] °C
Resolution of temperature measurement	0.1 [°C] for T<1000[°C] 1 [°C] for T>1000[°C]	
Temperature measurement error	< 0.3 [°C] ± 2 digits for T<200.0[°C] < 0.7 [°C] ± 1 digit for 200.0<T<500.0[°C] < 1.5 [°C] ± 1 digit for 500.0<T<1000[°C] < 2 [°C] ± 1 digit for T>1000[°C]	
Reading temperature period	1 [sec.]	
Range of parameters	like in table 3	
Type of outputs	mechanical relay	
Max. current of relay	5 [A]	
Max. switching voltage	250 [V] AC	
Max. switching power	1000 [VA]	
Max. frequency switching	600 cycle/h at nominal duty 72 000 cycle/h without duty	
Protection rating	IP 40 from front wall IP 30 from rear (connectors) wall	
Power supply	230V +10% -20%, 5..60Hz, 3VA	
Ambient temperature	0 ..+50 [°C]	
Relative humidity	< 80 [%]	
Weight	ca. 0.4 [kg]	
Dimensions (h x w x d)	48 x 96 x 128 [mm]	
Mounting window dimensions	44 x 91 [mm]	